



INSTALLATION INSTRUCTIONS

ZEUS™ SERIES

ZEUS™ Series Surge Protective Device (SPD)



Danger – Hazard of Electrical Shock, Explosion or Arc Flash

- Only qualified licensed electricians should install or service SPDs
- Verify that all power circuits are de-energized before making connections. SPDs should never be installed or serviced when energized or during electrical storms
- Follow safe electrical work practices and use appropriate safety precautions including Personal Protection Equipment (PPE)
- Confirm XO N-G bonding at upstream transformer
- When used in outdoor applications, customer must seal the conduit nipple using watertight fittings (not included) to ensure watertight connection
- Read this manual in its entirety prior to installation
- These installation instructions do not replace the national or local electrical codes
- Failure to follow these instructions can result in death, serious injury and/or equipment damage
- Caution – Ungrounded power systems are inherently unstable and can produce excessively high line-to-ground voltages during certain fault conditions. During these fault conditions any electrical equipment, including an SPD, may be subjected to voltages which exceed their designed ratings. This information is being provided to the user so that an informed decision can be made before installing any electrical equipment on an ungrounded power system.



INSTALLATION INSTRUCTIONS

ZEUS™ SERIES

1. Introduction

Thank you for purchasing a DITEK ZEUS® Surge Protective Device (SPD). This SPD is listed and certified to UL 1449 and CSA C22.2 (latest editions). This device is a Type 1 Listed SPD intended for parallel connection, installed adjacent, above or below existing electrical equipment. Supplemental Overcurrent Protection is not required to protect this unit.

Table of contents for this installation guide:

1. Introduction
2. Installation
3. Operation
4. Maintenance
5. Warranty

1.1 Safety Precautions

Check the facility grounding system. All grounding, bonding, and earthing must meet the National Electric Code® (NEC®), Canadian Electrical Code (CEC) and any other national, state and local electrical codes.

A licensed/qualified electrician must complete all instructions in this manual in accordance with the NEC, CEC, state, and local codes, or other applicable country codes. All applicable local electrical codes supersede these instructions.

Prior to installing this SPD, confirm that the system voltage and configuration matches the nameplate of the SPD. Installing a SPD that is improperly rated for the electrical system voltage could create a potentially hazardous condition, resulting in personnel injury and/or equipment damage.

1.2 Service Guidelines

Service of this unit consists of replacing the internal surge module, disconnect switch (including accessories) and/or human-machine interface.

There are no user-serviceable parts inside the replaceable surge module. Do not attempt to disassemble the surge module for safety precautions and to maintain product warranty.

1.3 Model Number Descriptions and Options

Each unit includes product labeling defining the model series, system voltage and configuration, surge capacity, short-circuit current rating (SCCR), maximum continuous operating voltage (MCOV), voltage protection rating (VPR) and product options. Check that the product nameplate matches your intended application.

D200M D300M	277/4803Y	D200 D300	T
Model Series	System Voltage /Configuration	Surge Capacity	Disconnect Switch

Catalog number D300M-277/4803YT shown for example only

Note: For additional configurations or if you do not see your configuration listed, please consult the factory.

Model Series

- D200M, D300M = ZEUS Type 1 SPD

Voltage and System Configuration

- 120/2401 = 120/240V Split Phase
- 120/2083Y = 120/208V 3-Phase WYE
- 277/4803Y = 277/480V 3-Phase WYE
- 2403D = 240V 3-Phase DELTA
- 4803D = 480V 3-Phase DELTA

Surge Capacity per Phase

- D200M = 200kA
- D300M = 300kA

Feature Package

- LED status indicators per phase including service, phase loss detection, audible alarm with silence, Form C dry contacts, EMI/RFI filter (self-certified, not UL evaluated), surge counter

Enclosure

- NEMA 1/12/3R/4 painted steel

Disconnect Switch

- No T = None
- T = UL98 Listed disconnect switch with through the door shaft and exterior operating handle



INSTALLATION INSTRUCTIONS

ZEUS™ SERIES

2. Installation

Warning: Conducting dielectric, megger, or hi-potential testing with the SPD installed will cause internal damage to the SPD and will void the product warranty. If these tests are desired, SPD must be disconnected from the power distribution system.

2.1 Unpacking and Preliminary Inspection

Inspect the entire shipment container for damage or signs of mishandling. Remove the packing materials and further inspect the unit for any shipping damages.

If any damages were found and is a result of shipping and handling, immediately file a claim with the shipping company and forward a copy to DITEK.

2.2 Planning (including Lead Lengths and Maximizing SPD Performance, Service Clearance)

SPDs should be located as close as possible to the circuit being protected in order to minimize voltage drop across conductors, optimizing SPD performance. When planning your installation, keep your leads as short as possible (minimum of 6") and straight (avoid sharp bends). Make sure your grounding lead is the shortest of all. Ensure the nearest circuit breaker positions are used. Additionally, twist leads together or use tie-wraps to optimize SPD performance.

Service Clearance is needed at the front of the unit. 36 inches minimum is the required distance in accordance with the National Electrical Code.

For optimum protection and for critical applications, a cascaded surge protection should be implemented at the service entrance and downstream locations as appropriate. Localized surge protection (individual equipment) should also be considered for sensitive loads and known areas of surge activity.

2.3 Mounting (including Outline Drawing and Weights)

The D200M, D300M series NEMA enclosed devices are intended for wall mount applications. Mechanical drawings, including mounting hole locations and weights can be found at the back of this manual.

2.4 Module Rotation Feature

Depending on desired cable entry location, the internal SPD module can be rotated in increments of 90 degrees to support top, bottom, left and right cable entry. To adjust for desired cable entry, disconnect RJ-45 communication cable from the SPD module. Remove RJ-45 cable from cord clip. Remove the four mounting screws in each corner of the backplate (SPD module does not need to be removed from backplate). Rotate to desired position. Re-install backplane using the four screws. Insert RJ-45 communication cable into appropriate RJ-45 cord clip. Re-connect RJ-45 communication cable.

Note: for illustrations below, RJ-45 communication cable and cord clips not shown in images below.



Desired orientation for bottom cable entry



Desired orientation for right cable entry



Desired orientation for top cable entry



Desired orientation for left cable entry

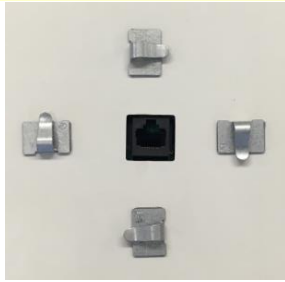

Note: RJ-45 communication cable must be secured properly using appropriate cord clip

Devices with the disconnect switch, option “T”, can only be positioned for top or bottom cable entry. For these models please plan accordingly to optimize device performance.

2.5 Conduit installation

Once pre-planning is completed and desired cable entry location is defined, remove an appropriately sized knockout from the electrical equipment to be protected. Create an appropriately sized and located hole in the SPD enclosure. Using approved wiring methods, determine the correct conduit for phase, neutral and ground conductors and install onto the SPD enclosure and electrical equipment to be protected (including seals and fittings appropriate for the enclosure rating). If using the Form C contacts (included in feature package B), route Form C conductors through a separate conduit.

2.6 Wiring Diagrams and System Configurations

Wiring diagrams per system configuration can be found at the back of this manual. Prior to installing this SPD confirm that the system voltage and configuration matches the nameplate of the SPD.

2.7 Wire Terminals, Wire Size and Terminal Torque

Wire terminals for phase and neutral will accept 8 to 2 AWG stranded copper conductors. The wire terminal for ground will accept 8 to 2/0 AWG stranded copper conductors. Per the wiring diagram, insert phase, neutral and ground conductors into designated terminal locations and torque to the following specifications. If your device is equipped with the disconnect switch option please proceed to the next section.

Model	Terminal Designation	Wire AWG		Torque (lbs-in)
		Min.	Max.	
D200M D300M	Phases A, B, C and Neutral as applicable	3	2	50
		6	4	45
		8	8	40
	Ground	3	2/0	50
		6	4	45
		8	8	40

2.8 Disconnect Switch Option

If ordered with disconnect switch option “T” device will include UL98 Listed load-break disconnect switch. The

disconnect switch provides manual disconnection means for the phase conductors and the neutral conductor. Ground is not switched.

Wire terminals for phase and neutral will accept 8 to 1/0 AWG stranded copper conductors. The wire terminal for ground will accept 8 to 2/0 AWG stranded copper conductors. Per the wiring diagram, insert phase, neutral and ground conductors into designated terminal locations and torque to the following specifications.

Model	Terminal Designation	Wire AWG		Torque (lbs-in)
		Min.	Max.	
D200M...T D300M...T	Phases A, B, C and Neutral as applicable	8	1/0	55
		3	2/0	50
	Ground	6	4	45
		8	8	40

2.9 Form C Dry Contact and Audible Alarm Option

Dry contacts will change state and audible alarm will sound upon SPD module end-of-life or phase loss detection. The audible alarm can be silenced by pressing the “Silence Alarm” button on the device interface.



Terminal Block for Dry Contacts

Wire terminals for the remote status indicator will accept 30 to 12 AWG solid or stranded copper conductors.

Model	Terminal Designation	Wire AWG		Torque (lbs-in)	
		Min.	Max.	Min.	Max.
D200M D300M D200M.....T D300M.....T	Remote Status	30	12	5	7

2.10 Power-up

Note: Double check for open circuit prior to energizing. Energize and confirm proper operation of indicators, alarms and/or options/features. If Red service indicator is illuminated or audible alarm and dry contacts cycle, de-energize immediately and contact DITEK for assistance.

3. Operation

All visual indicators and controls are located on the human-machine interface (HMI) (aka diagnostic display). The HMI is located on the front of the SPD enclosure door.

The ZEUS Series features multi-colored LED health status indicators for A, B, C phase and neutral as well as a red LED service indicator. Also included is a surge counter with reset button and an audible alarm with silence button.

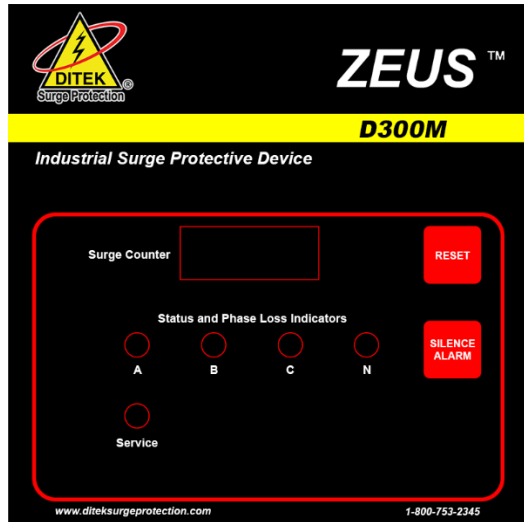

HMI Features

3.1 LED Status Indicators

Every TPMOV suppression element within the SPD is monitored. Green LEDs indicate correct operation. For device health indication, the following colors apply:

- Green = 67 to 100% life remaining
- Amber = 34 to 66% life remaining
- Red = 0 to 33% life remaining

If the red service LED is illuminated this means the device has reached end-of-life and the SPD module must be replaced.

3.2 Surge Counter

The surge counter LCD is a six-digit numeric display. The counter will register the number of surge events on all modes L-L, L-N, L-G and N-G since the last reset. Each event will increment the counter by (+1). By pressing the reset button, the device memory will be cleared and the counter reset to (0). The counter is equipped with a backup storage which will retain information indefinitely even upon power loss.

3.3 Audible Alarm

The audible alarm will sound upon SPD module end-of-life or phase loss detection. The audible alarm can be silenced by pressing the “Silence Alarm” button on the device interface.

3.4 Dry Contact

Dry contacts will change state upon SPD module end-of-life or phase loss detection.

The green dry contact terminal block located on the SPD module includes (1) set of Normally Open (NO) and Normally Closed (NC) contacts.

Form C Dry Contact Ratings:

- 125VAC, 1A Resistive
- 30VDC, 2A General Purpose

4. Maintenance

Perform periodic inspection of the SPD status indicator lights as part of the preventive maintenance schedule. De-energize unit and check torque settings, re-tighten as necessary.

Promptly service the SPD when an alarm state exists.

Use dry contacts to signal an alarm state to the central supervisory system for unmanned, inaccessible, or critical installations.

4.1 Troubleshooting and Service

Please contact DITEK Technical Support for any service or product related issue.

- Phone: 888-472-6100 (USA)
- Email: www.diteksurgeprotection.com

4.2 Module Replacement

When service indicator is illuminated, the SPD module has reached end-of-life and must be replaced. (Note: if service indicator is illuminated, the device is no longer protecting your equipment. Make sure to service the unit as soon as possible to avoid equipment damage due to surge events)



SPD Module (D200M-....M / D300M-....M)

The following steps should be taken to remove the SPD module: Disconnect all power sources feeding the SPD (via breaker or disconnect switch or utility if installed as a TYPE1 SPD). Loosen phase, neutral and ground wire terminals so that the conductors are no longer bound to the SPD module (for both disconnect switch and non-disconnect switch options). Remove HMI RJ-45 communication cable from face of the module and cord clip. Remove green dry contact terminal from SPD module by pulling on terminal block (option for feature package B only). Remove the eight mounting screws holding the SPD module to the backplane. Remove SPD module and discard. Install new SPD module by repeating the steps for removal in reverse order.

4.3 HMI (Human-Machine Interface) Replacement

When replacing the HMI, do not remove the HMI overlay (exterior facing label). Only the HMI circuit board should be replaced. The HMI circuit board is located on the inside of the enclosure door to which the overlay is adhered to. To remove the cover, first disconnect the RJ-45 communication cable and the overlay ribbon cable from the HMI. Remove the four mounting nuts and washers in each corner of the circuit board from the PEM studs. Remove the HMI from the enclosure door. Do not remove the spacers that are located between the HMI and the enclosure door. Install the new HMI by aligning the four mounting holes in the corner of the circuit board onto the PEM studs of the enclosure door. Re-install mounting washers and nuts onto each PEM stud, tighten securely.

Re-connect RJ-45 communication cable and overlay ribbon cable to the HMI.

Note: HMI feature package must match original feature package of SPD. Replacement HMI catalog numbers (includes circuit board only):

- Consult Factory

4.4 Disconnect Switch Replacement (option)

The disconnect switch is directly mounted to the enclosure backplate. To remove, loosen the disconnect switch line side wire terminals so that the conductors from the SPD module are no longer bound to the switch; remove the two mounting screws that are holding the switch to the backplate; remove disconnect switch and discard. Conductors from the SPD module to the switch do not need to be removed. Install new disconnect switch by first placing it in position, making sure the SPD module conductors are re-inserted into switch line side terminals; Re-install the two mounting screws; re-torque SPD module conductors according to table.

5. Warranty

DITEK warrants ZEUS Series for a period of 10 years from the date of delivery to the purchaser to be free from defects in both workmanship and materials. To read the entire warranty terms and conditions, please visit www.diteksurgeprotection.com

Wiring Diagrams

Split Phase, 3-Wire + Ground
D200M-120/2401, D300M-120/2401

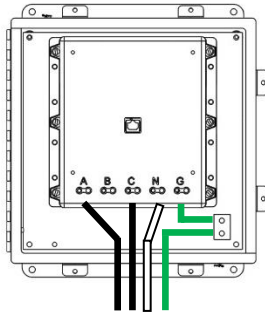
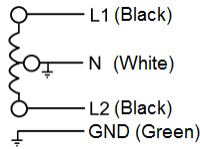

Split Phase, 3-Wire + Ground
D200M-120/2401T, D300M-120/2401T

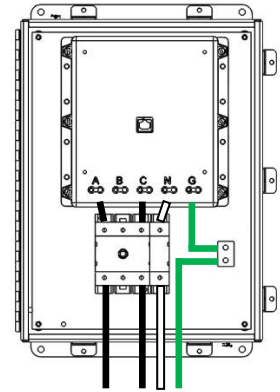
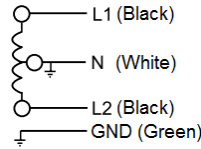

3-Phase WYE, 4-Wire + Ground
D200M-120/2083Y, D300M-120/2083Y
D200M-277/4803Y, D300M-277/4803Y

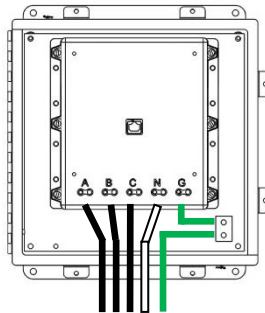
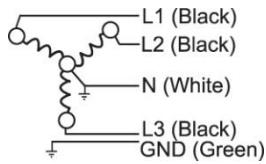

3-Phase WYE, 4-Wire + Ground
D200M-120/2083YT, D300M-120/2083YT
D200M-277/4803YT, D300M-277/4803YT

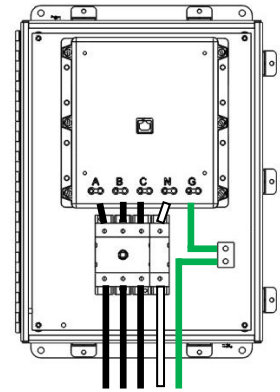
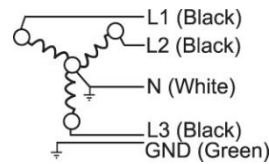

3-Phase DELTA, 3-Wire + Ground
D200M-2403D, D300M-2403D
D200M-4803D, D300M-4803D

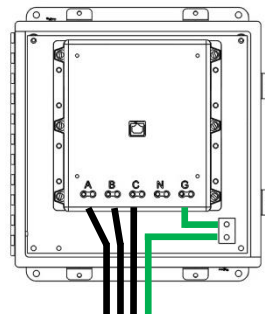
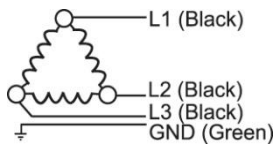

3-Phase DELTA, 3-Wire + Ground
D200M-2403DT, D300M-2403DT
D200M-4803DT, D300M-4803DT

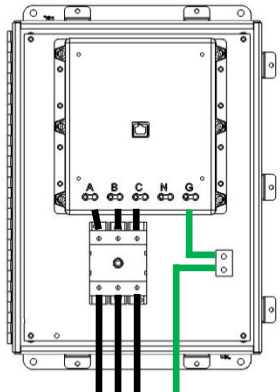
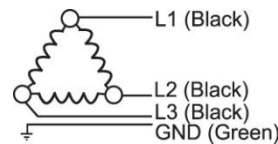

Mechanical Drawings

D200M
D300M

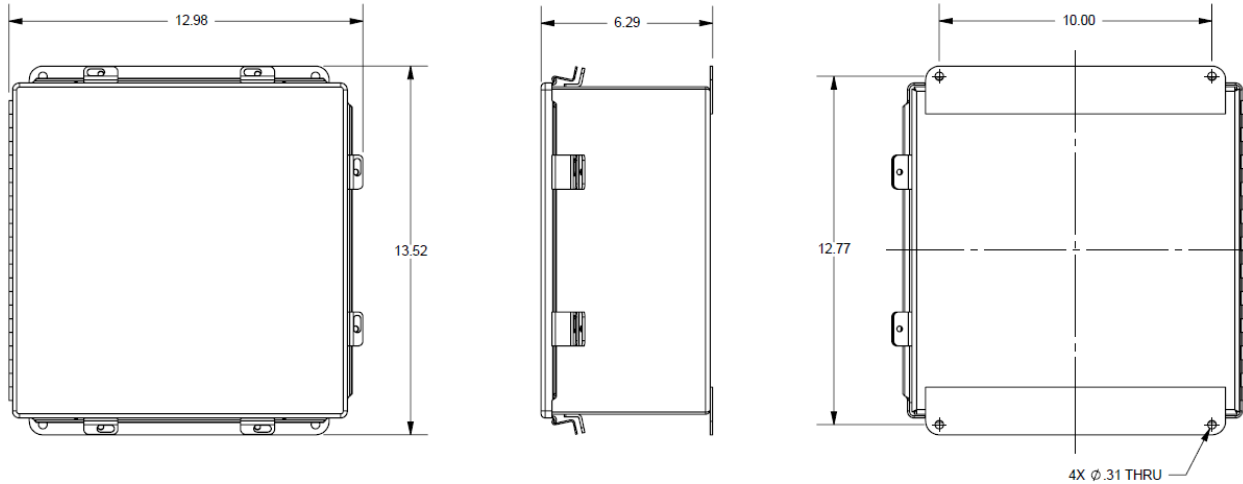

Maximum Weight = 23 lbs

D200M...T
D300M...T

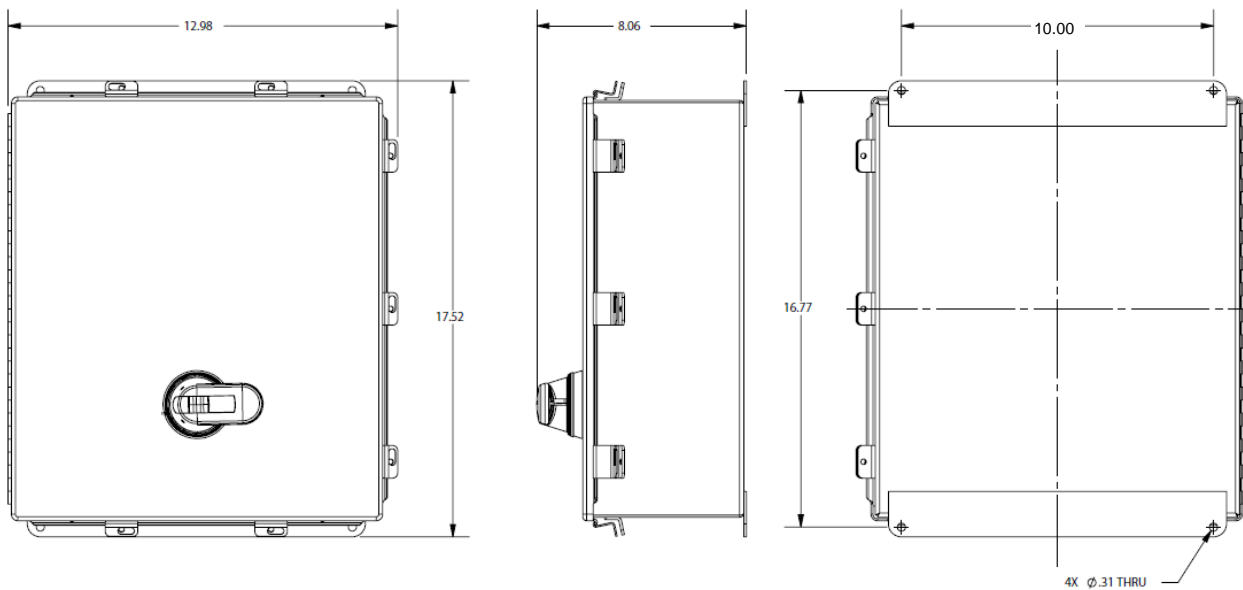

Maximum Weight = 27 lbs