



DTK-UPS1000R+/DTK-UPS1500R+
DTK-UPS2000R+/DTK-UPS3000R+ Online UPS

USER MANUAL

Uninterruptible Power Supply System

Version: 1.0

INT-100209-001 Rev 1

Table of Contents

1. Important Safety Warning	1
1-1. Transportation	1
1-2. Preparation	1
1-3. Installation.....	1
1-4. Operation.....	2
1-5. Maintenance, service and faults.....	2
2. Installation and setup	5
2-1. Rear panel view.....	5
2-2. Operating principle	6
2-3. Install the UPS	6
2-4. Setup the UPS.....	7
2-5. Battery Replacement	10
2-6. Battery Kit Assembly.....	12
3. Operations	14
3-1. Button operation	14
3-2. LCD Panel	14
3-3. Audible Alarm.....	16
3-4. LCD display wordings index.....	16
3-5. UPS Setting	17
3-6. Operating Mode Description	21
3-7. Faults Reference Code.....	22
3-8. Warning indicator	22
4. Troubleshooting.....	23
5. Storage and Maintenance.....	24
6. Specifications	25

1. Important Safety Warning

SAVE THESE INSTRUCTIONS - This manual contains important instructions that should be followed during installation and maintenance of the UPS and batteries

Please comply with all warnings and operating instructions in this manual strictly. Do not operate this unit before reading through all safety information and operating instructions carefully

1-1. Transportation

- Please transport the UPS system only in the original package to protect against shock and impact.

1-2. Preparation

- Condensation may occur if the UPS system is moved directly from cold to warm environment. The UPS system must be absolutely dry before being installed. Please allow at least two hours for the UPS system to acclimate the environment.
- Do not install the UPS system near water or in moist environments.
- Do not install the UPS system where it would be exposed to direct sunlight or near heater.
- Do not block ventilation holes in the UPS housing.

1-3. Installation

- Do not connect appliances or devices which would overload the UPS system (e.g. laser printers) to the UPS output sockets.
- Place cables in such a way that no one can step on or trip over them.
- Do not connect domestic appliances such as hair dryers to UPS output sockets.
- The UPS can be operated by any individuals with no previous experience.
- Connect the UPS system only to an earthed shockproof outlet which must be easily accessible and close to the UPS system.
- Please use only VDE-tested, CE-marked (or UL-marked for 100/110/115/120/125 VAC models) mains cable (e.g. the mains cable of your computer) to connect the UPS system to the building wiring outlet (shockproof outlet).
- Please use only VDE-tested, CE-marked (or UL-marked for 100/110/115/120/125 VAC models) power cables to connect the loads to the UPS system.
- When installing the equipment, it should ensure that the sum of the leakage current of the UPS and the connected devices does not exceed 3.5mA.
- Temperature Rating - Units are considered acceptable for use in a maximum ambient of 40°C (104°F).
- For Pluggable Equipment - The socket-outlet shall be installed near the equipment and shall be easily accessible.
- CAUTION: The unit is heavy. Lifting the unit requires a minimum of two people.
- Batteries with minimum case flame rating V-2 are intended for use in a computer room as defined in the Standard for the Protection of Information Technology Equipment, ANSI/NFAP 75. Batteries with case flame rating HB are not intended for use in a computer room. (US installations only.)

1-4. Operation

- Do not disconnect the mains cable on the UPS system or the building wiring outlet (shockproof socket outlet) during operations since this would cancel the protective earthing of the UPS system and of all connected loads.
- The UPS system features its own, internal current source (batteries). The UPS output sockets or output terminals block may be electrically live even if the UPS system is not connected to the building wiring outlet.
- In order to fully disconnect the UPS system, first press the OFF/Enter button to disconnect the mains.
- Prevent no fluids or other foreign objects from inside of the UPS system.
- The EPO and USB circuits are an IEC 60950-1 safety extra low voltage (SELV) circuit. This circuit must be separated from any hazardous voltage circuits by reinforced insulation.

1-5. Maintenance, service and faults

- The UPS system operates with hazardous voltages. Repairs may be carried out only by qualified maintenance personnel.
- **Caution** - risk of electric shock. Even after the unit is disconnected from the mains (building wiring outlet), components inside the UPS system are still connected to the battery and electrically live and dangerous.
- Before carrying out any kind of service and/or maintenance, disconnect the batteries and verify that no current is present and no hazardous voltage exists in the terminals of high capability capacitor such as BUS-capacitors.
- To avoid electrical shock, turn off the unit and unplug it from the AC power source before servicing the battery
- Only persons are adequately familiar with batteries and with the required precautionary measures may replace batteries and supervise operations. Unauthorized persons must be kept well away from the batteries.
- **Caution** - risk of electric shock. The battery circuit is not isolated from the input voltage. Hazardous voltages may occur between the battery terminals and the ground. Before touching, please verify that no voltage is present!
- **Caution** - Do not dispose of batteries in a fire. The batteries may explode.
- **Caution** - Do not open or mutilate batteries. Released electrolyte is harmful to the skin and eyes. It may be toxic.
- A battery can may cause a risk of electrical shock and high short-circuit current. The following precautions should be observed when working on batteries:
 - a) Remove watches, rings, or other metal objects.
 - b) Use tools with insulated handles.
 - c) Wear rubber gloves and boots.
 - d) Do not lay tools or metal parts on top of batteries.
 - e) Disconnect charging source prior to connecting or disconnecting battery terminals.
 - f) Determine if battery is inadvertently grounded. If inadvertently grounded, remove source from ground. Contact with any part of a grounded battery can result in electrical shock. The likelihood of such shock can be reduced if such grounds are removed during installation and maintenance.

- When changing batteries, install the same number and same type of batteries or battery packs.

Manufacture	Type	Battery Case Flame Rating	Rating
HITACHI CHEMICAL ENERGY TECHNOLOGY CO LTD (MH14533)	GP 1272	HB	12 V, 7.2 Ah
	GP 1272 F2	HB	12 V, 7.2 Ah
	GP 1272 FR	V-0	12 V, 7.2 Ah
	GP 1272 F2FR	V-0	12 V, 7.2 Ah
	UPS 12360 7	HB	12 V, 7 Ah
	UPS 12360 7 FR	V-0	12 V, 7 Ah
	UPS 12460	HB	12 V, 9.0 Ah
	UPS 12460 FR	V-0	12 V, 9.0 Ah
	HR 1234W	HB	12 V, 8.5 Ah
	HR 1234W FR	V-0	12 V, 8.5 Ah
	UPS 12580	HB	12 V, 9.4 Ah
	UPS 12580 FR	V-0	12 V, 9.4 Ah
TAIWAN YUASA BATTERY CO LTD (MH28947)	NPW36-12	HB	12 V, 7.0 Ah
	NPW36-12FR	V-0	12 V, 7.0 Ah
	UXW360-12	HB	12 V, 7.0 Ah
	UXW360-12FR	V-0	12 V, 7.0 Ah
	UXW460-12	HB	12 V, 8.0 Ah
	UXW460-12FR	V-0	12 V, 8.0 Ah
	NPW45-12	HB	12 V, 7.5 Ah
	NPW45-12FR	V-0	12 V, 7.5 Ah
	UXW580-12	HB	12 V, 9.0 Ah
	UXW580-12 FR	V-0	12 V, 9.0 Ah
	NPX-35	HB	12 V, 8.0 Ah
	NPX-35 FR	V-0	12 V, 8.0 Ah
KUNG LONG BATTERIES INDUSTRIAL CO LTD(MH16982)	WPS580	HB	12 V, 9.0 Ah
	WPS580V0	V-0	12 V, 9.0 Ah
	WP7-12(28W)	HB	12 V, 7.0 Ah
	WP7-12(28W)V0	V-0	12 V, 7.0 Ah
	WP1234W	HB	12 V, 8.5 Ah
	WP1234WV0	V-0	12 V, 8.5 Ah
	WPS7-12	HB	12 V, 7.0 Ah
	WPS7-12V0	V-0	12 V, 7.0 Ah
	WPS8-12	HB	12 V, 8.0 Ah
	WPS8-12V0	V-0	12 V, 8.0 Ah
SHIMASTU ELECTRONIC TECHNOLOGY LTD (MH28269)	NP7-12	V-0	12 V, 7.0 Ah
	NP9.0-12	V-0	12 V, 9.0 Ah
FUJIAN MINHUA POWER SOURCE CO LTD (MH47104)	MS7-12	V-0	12 V, 7.0 Ah
	MS9-12	V-0	12 V, 9.0 Ah
SHENZHEN CENTER POWER TECHNOLOGY CO LTD (MH25860)	CP1270	HB	12 V, 7.0 Ah
	CP1290	HB	12 V, 9.0 Ah
LEOCH BATTERY SHENZHEN CORP (MH26866)	DJW12-7.0	HB	12 V, 7.0 Ah
	DJW12-9.0	HB	12 V, 9.0 Ah
	DJW12-10	HB	12 V, 10.0 Ah
SHENZHEN RITAR POWER	RT1270	HB	12 V, 7.0 Ah

CO LTD (MH28539)	RT1290	HB	12 V, 9.0 Ah
------------------	--------	----	--------------

- Please replace the fuse only with the same type and amperage in order to avoid fire hazards.
- Do not dismantle the UPS system.
- **NOTE:** This equipment has been tested and found to comply with the limits for a Class A digital device, pursuant to part 15 of the FCC Rules. These limits are designed to provide reasonable protection against harmful interference when the equipment is operated in a commercial environment. This equipment generates, uses, and can radiate radio frequency energy and, if not installed and used in accordance with the instruction manual, may cause harmful interference to radio communications. Operation of this equipment in a residential area is likely to cause harmful interference in which case the user will be required to correct the interference at his own expense.
- **WARNING:** Changes or modifications not expressly approved by the party responsible for compliance could void the user's authority to operate the equipment.

2. Installation and setup

NOTE: Before installation, please inspect the unit. Be sure that nothing inside the package is damaged. Please keep the original package in a safe place for future use.

2-1. Rear panel view

DTK-UPS1000R+ / DTK-UPS1500R+

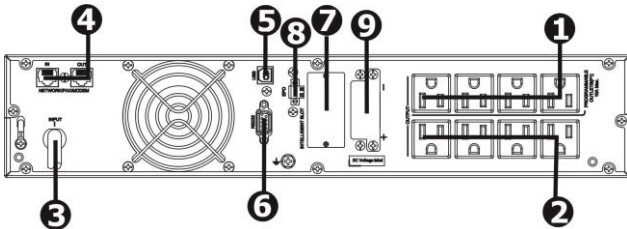

DTK-UPS2000R+

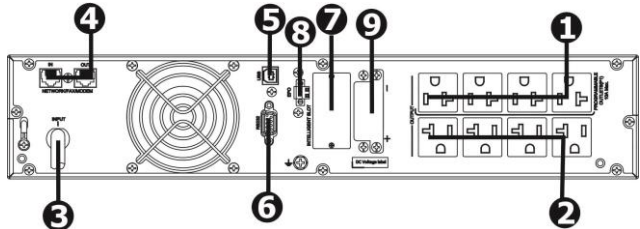

DTK-UPS3000R+

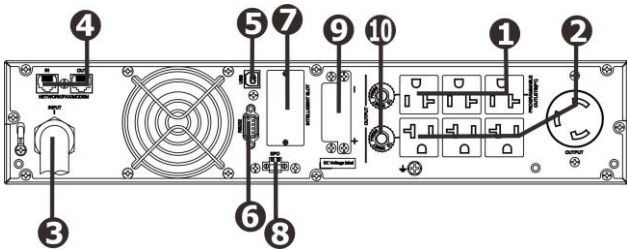

1. Programmable outlets: connect to non-critical loads.
2. Output receptacles: connect to mission-critical loads.
3. AC input
4. Network/Fax/Modem surge protection
5. USB communication port
6. RS-232 communication port
7. SNMP intelligent slot
8. Emergency power off function connector (EPO)
9. External battery connection
10. Output circuit breaker

2-2. Operating principle

The operating principle of the UPS is shown as below

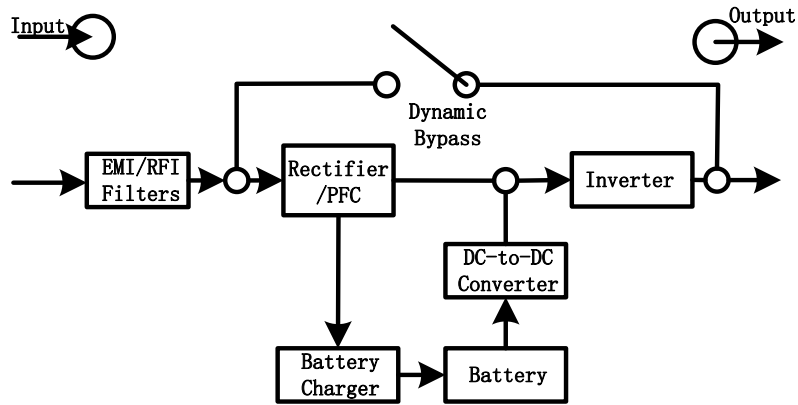

The UPS is composed of mains input, EMI/RFI filters, rectifier/PFC, inverter, battery charger, DC-to-DC converter, battery, dynamic bypass and UPS output.

2-3. Install the UPS

This UPS can be either displayed on the desk or mounted in the 19" rack chassis. Please choose proper installation to position this UPS.

Rack-mount Installation

Step 1

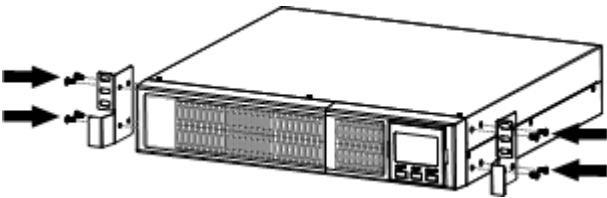

Step 2

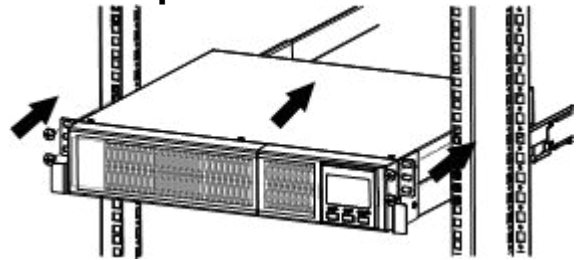

UPS Tower Installation

Step 1

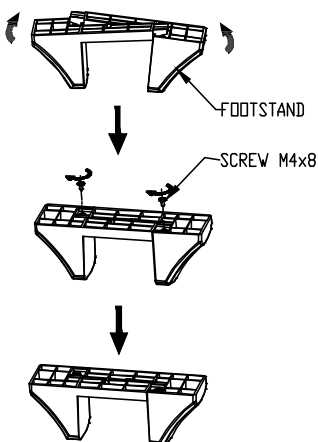

Step 2

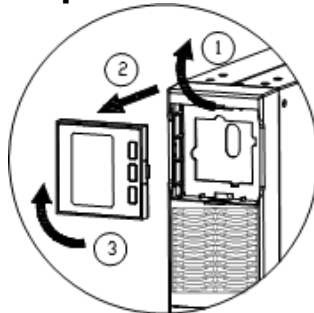

Step 3

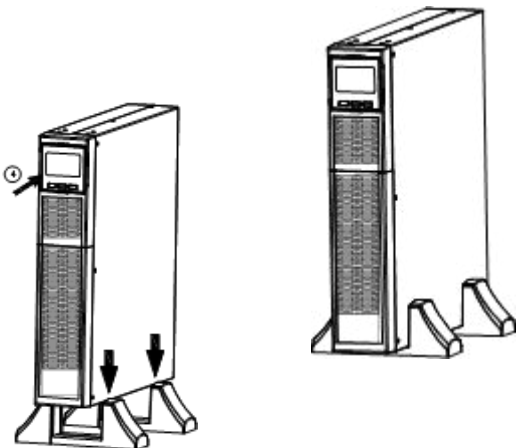

Tower Installation with battery pack

Step 1

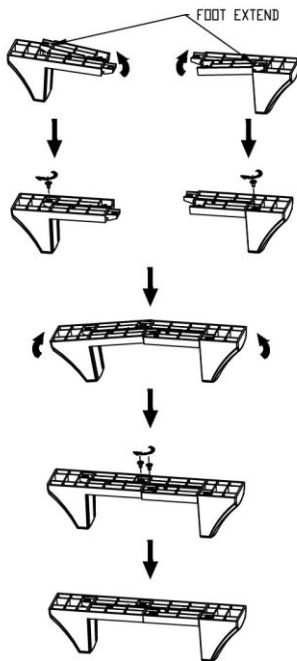

Step 2

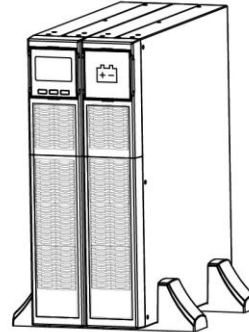

2-4. Setup the UPS

Before installing the UPS, please read below to select proper location to install UPS.

1. UPS should be placed on the flat and clean surface. Place it in an area away from vibration, dust, humidity, high temperature, flammable liquids, gases, corrosive and conductive contaminants. Install the UPS indoors in a clean environment, where it is away from window and door. Maintain minimum clearance of 100mm in the bottom of the UPS to avoid dust and high temperature.
2. It's required to maintain maximum altitude of 3000m to keep UPS normal operation at full load UPS.
3. Place UPS:

It's equipped with fan for cooling. Therefore, place the UPS in a well-ventilated area. It's required to maintain minimum clearance of 100mm in the front of the UPS and 300mm in the back and two sides of the UPS for heat dissipation and easy-maintenance.

Step 1: External battery connection

For safety consideration, the RT UPS is shipped out from factory without connecting battery wires. Before connecting to external batteries, it's required to have the internal battery wire disconnected. Follow the below steps to make external battery connection.

1. Turn off UPS and remove power plug from the mains.
2. Remove front panel and disconnect internal battery wire. (only available for RT models with internal battery wire connected)

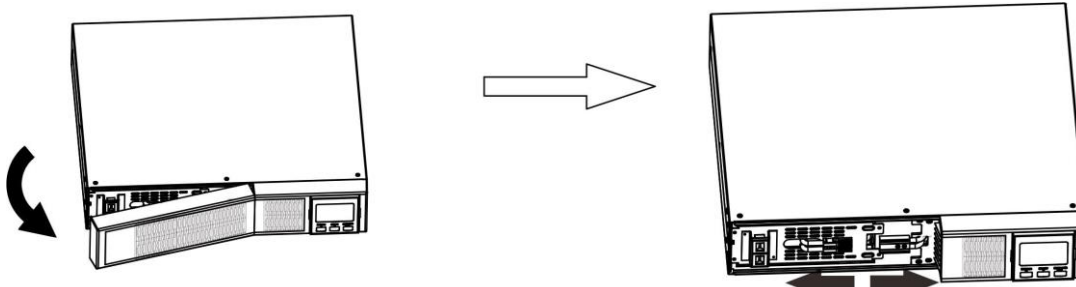

3. Remove the cover of the external battery connector by using a screwdriver.

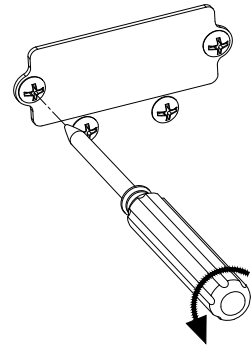

4. Plug the battery cable into the external battery connector of the UPS and the battery pack(s).

Note: If you have multiple battery packs available, connect them serially. An example is shown in the diagram below (connecting the second battery connector of the first battery pack to the first battery connector of the second battery pack).

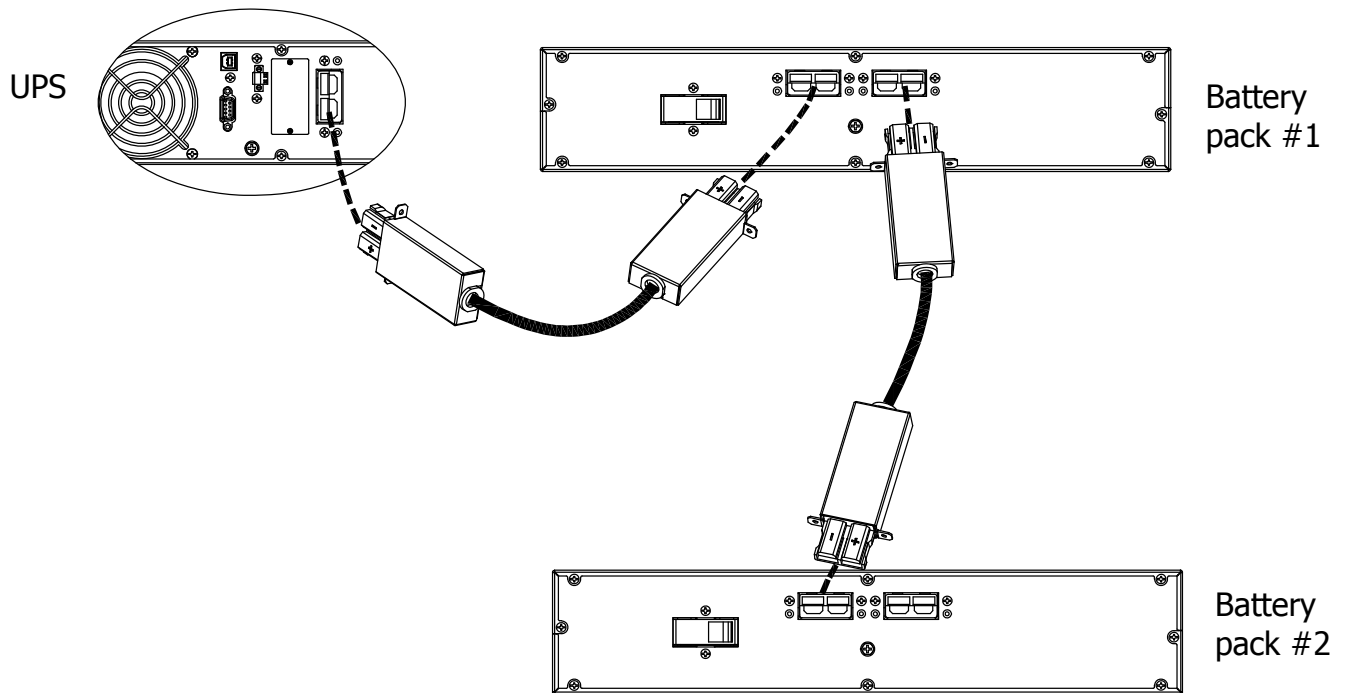

5. Stabilize the connector to the UPS and the battery pack(s) by fixing screws as shown below diagram.

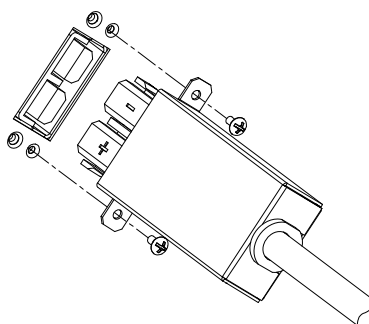

6. Connect internal battery connector and put the front panel back to the unit.

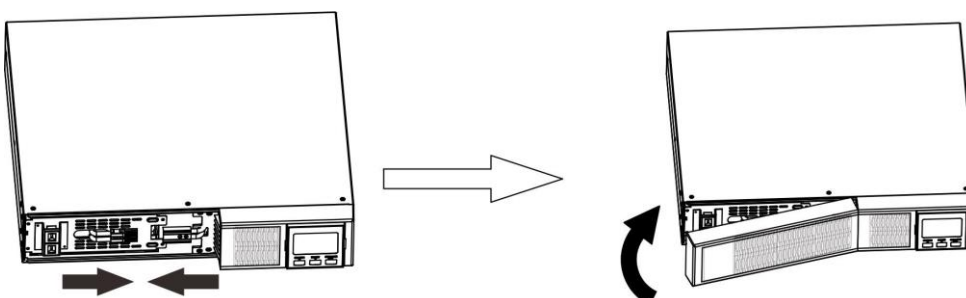

Step 2: UPS input connection

Plug the UPS into a two-pole, three-wire, grounded receptacle only. Avoid using extension cords. The power cord is attached to the UPS. The input plug is a NEMA 5-15P for DTK-UPS1000R+/ DTK-UPS1500R+models, NEMA 5-20P for DTK-UPS2000R+ model and NEMA L5-30P for DTK-UPS3000R+ model.

To reduce the risk of fire, connect only to a circuit provided with (@) a maximum branch circuit overcurrent protection in accordance with the National Electrical Code, ANSI/NFPA 70 and the Canadian Electrical Code, Part I, C22.1.

Model	(@)
DTK-UPS1000R+	20A
DTK-UPS1500R+	20A
DTK-UPS2000R+	20A
DTK-UPS3000R+	40A

Note: Check if the site wiring fault indicator lights up in LCD panel. It will be illuminated when the UPS is plugged into an improperly wired utility power outlet (Refer to Troubleshooting section).

Step 3: UPS output connection

There are two kinds of outputs: programmable outlets and general outlets. Please connect non-critical devices to the programmable outlets and critical devices to the general outlets. During power failure, you may extend the backup time to critical devices by setting shorter backup time for non-critical devices.

Step 4: Communication connection

Communication port:

USB port



RS-232 port

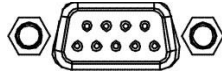

Intelligent slot



To allow for unattended UPS shutdown/start-up and status monitoring, connect the communication cable one end to the USB/RS-232 port and the other to the communication port of your PC. With the monitoring software installed, you can schedule UPS shutdown/start-up and monitor UPS status through PC.

The UPS is equipped with intelligent slot perfect for either SNMP or AS400 card. When installing either SNMP or AS400 card in the UPS, it will provide advanced communication and monitoring options.

Step 5: Network connection

Network/Fax/Phone surge port



Connect a single modem/phone/fax line into surge-protected "IN" outlet on the back panel of the UPS unit. Connect from "OUT" outlet to the equipment with another modem/fax/phone line cable.

Step 6: Disable and enable EPO function

This UPS is equipped with EPO function. By default, the UPS is delivered from factory with Pin 1 and pin 2 closed (a metal plate is connected to Pin 1 and Pin2) for UPS normal operation. To activate EPO function, remove two screws on EPO port and metal plate will be removed.

Note: The EPO function logic can be set up via LCD setting. Please refer to program 16 in UPS setting for the details.

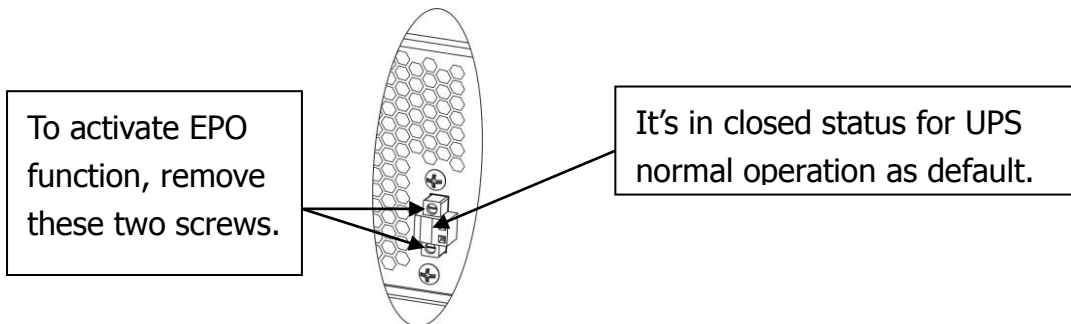

Step 7: Turn on the UPS

Press the ON/Mute button on the front panel for two seconds to power on the UPS.



Note: The battery charges fully during the first five hours of normal operation. Do not expect full battery run capability during this initial charge period.

Step 8: Install software

For optimal computer system protection, install UPS monitoring software to fully configure UPS shutdown. Use supplied RS-232 or USB communication cable to connect RS-232/USB port of UPS and RS-232/USB port of PC. Then, follow below steps to install monitoring software.

1. Insert the included installation CD into CD-ROM drive and then follow the on-screen instructions to proceed software installation. If there no screen shows 1 minute after inserting the CD, please execute setup.exe file for initiating software installation.
2. Follow the on-screen instructions to install the software.
3. When your computer restarts, the monitoring software will appear as an orange plug icon located in the system tray, near the clock.

2-5. Battery Replacement

When the icons of  and  are flashing in LCD display and alarm is sounding every 2 seconds, it's time to replace batteries. Contact your service representative to replace batteries. Do not disconnect battery connectors under load. If you prefer to remove input power to change the batteries, press the OFF button on the front panel for two seconds to power off the UPS and switch off utility power where the UPS is connected.

NOTE 1 : DO NOT DISCONNECT the batteries while the UPS is in Battery mode.

NOTE 2 : A small amount of arcing may occur when connecting the internal batteries. This is normal condition and no harm for personnel. Connect the cables quickly and firmly.

NOTE 3 : This UPS is equipped with internal batteries and only service person can replace the batteries.

NOTE 4 : Upon battery disconnection, equipment is not protected from power outages.

CAUTION!! Consider all warnings, cautions, and notes before replacing batteries.

Step 1

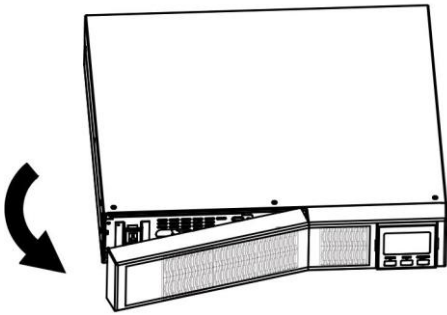

Remove front panel.

Step 2

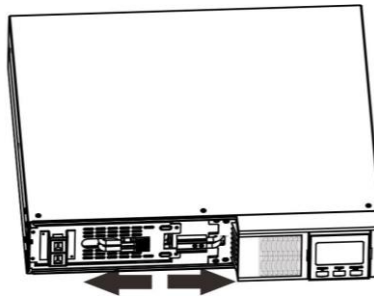

Disconnect battery wires.

Step 3

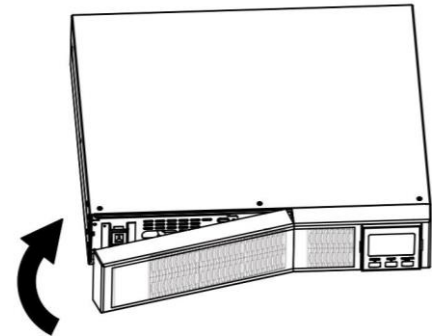

Pull out the battery box by removing two screws on the front panel.

Step 4

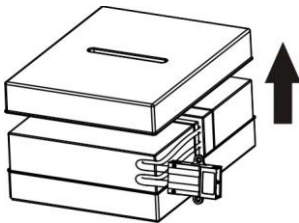

Remove the top cover of battery box and replace the inside batteries.

Step 5

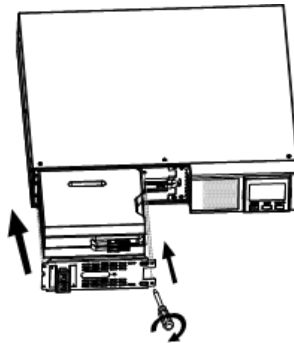

After replacing the batteries, put the battery box back to original location and screw it tightly.

Step 6

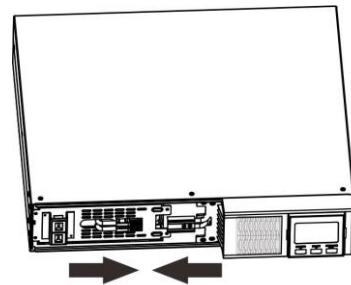

Re-connect the battery wires.

Step 7

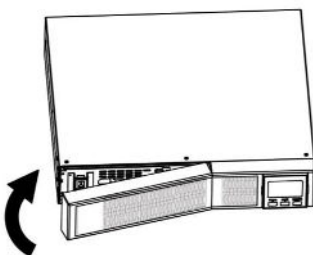

Put the front panel back to the unit.

2-6. Battery Kit Assembly

NOTICE: Please assemble battery kit first before installing it inside of UPS. Please select correct battery kit procedure below to assemble it.

2-battery kit

Step 1: Remove adhesive tapes.

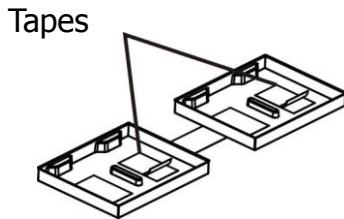

Step 3: Put assembled battery packs on one side of plastic shells.

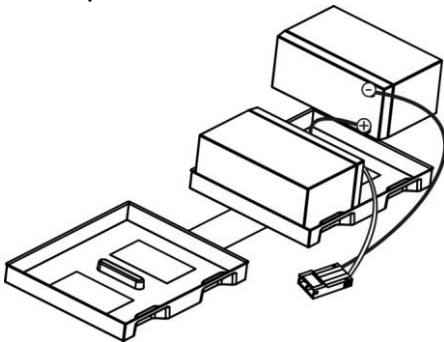

Step 2: Connect all battery terminals by following below chart.

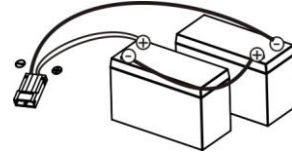

Step 4: Cover the other side of plastic shell as below chart. Then, battery kit is assembly well.

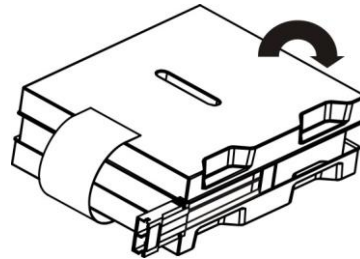

3-battery kit

Step 1: Remove adhesive tapes.

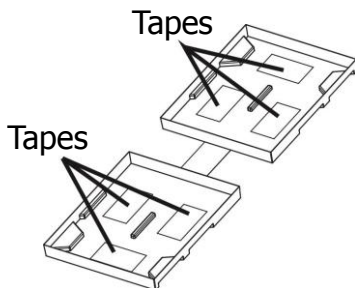

Step 3: Put assembled battery packs on one side of plastic shells as below chart.

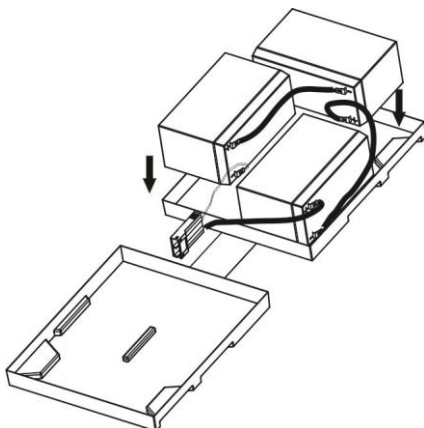

Step 2: Connect all battery terminals by following below chart.

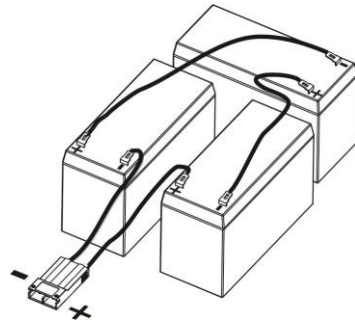

Step 4: Cover the other side of plastic shell as below chart. Then, battery kit is assembly well.

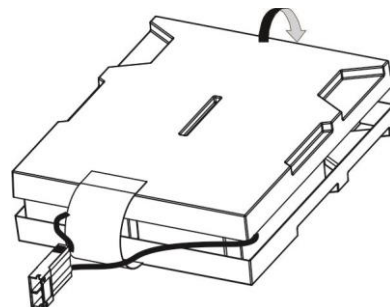

4-battery kit

Step 1: Remove adhesive tapes.

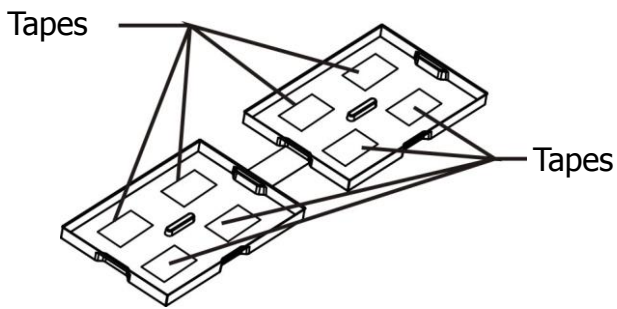

Step 2: Connect all battery terminals by following below chart.

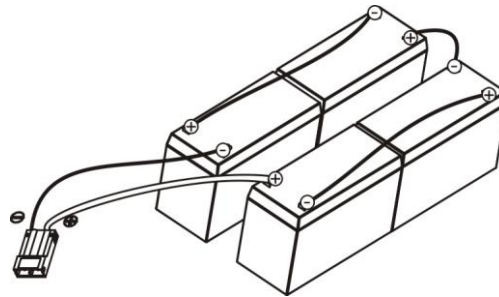

Step 3: Put assembled battery packs on one side of plastic shells.

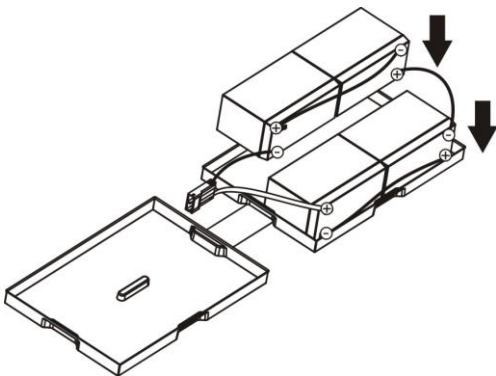

Step 4: Cover the other side of plastic shell as below chart. Then, battery kit is assembly well.

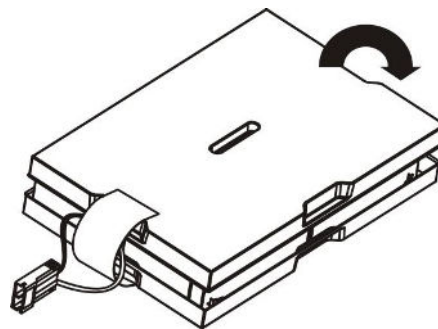

6-battery kit

Step 1: Remove adhesive tapes.

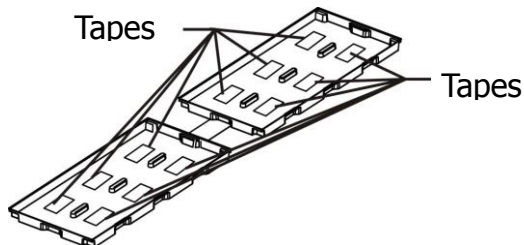

Step 2: Connect all battery terminals by following below chart.

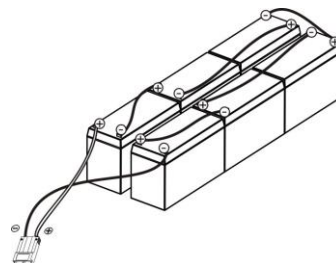

Step 3: Put assembled battery packs on one side of plastic shells.

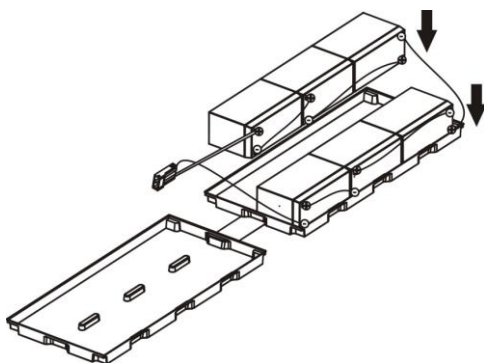

Step 4: Cover the other side of plastic shell as below chart. Then, battery kit is assembly well.

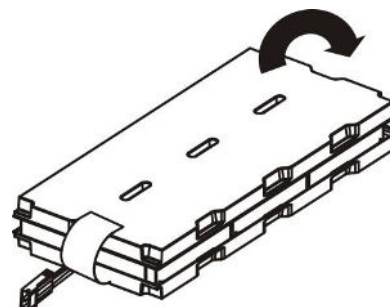









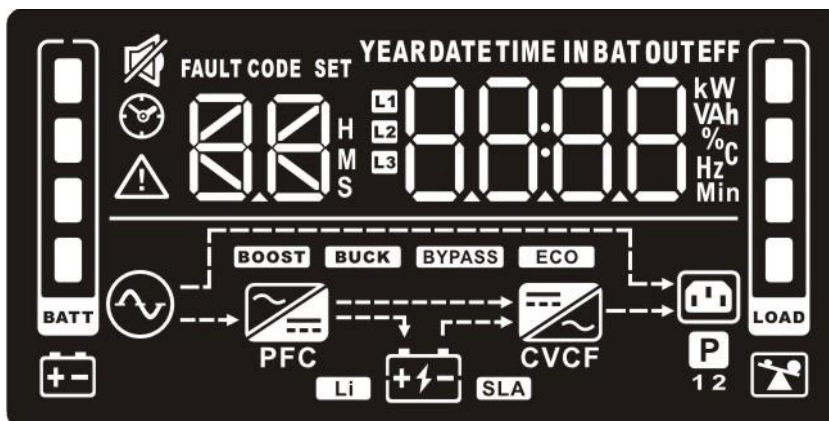





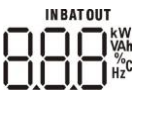





3. Operations

3-1. Button operation

Button	Function
ON/Mute Button	<ul style="list-style-type: none"> ➤ Turn on the UPS: Press and hold ON/Mute button for at least 2 seconds to turn on the UPS. ➤ Mute the alarm: After the UPS is turned on in battery mode, press and hold this button for at least 3 seconds to disable or enable the alarm system. But it's not applied to the situations when warnings or errors occur. ➤ Up key: Press this button to display previous selection in UPS setting mode. ➤ Switch to UPS self-test mode: Press ON/Mute buttons for 3 seconds to enter UPS self-testing while in AC mode, ECO mode, or converter mode.
OFF/Enter Button	<ul style="list-style-type: none"> ➤ Turn off the UPS: Press and hold this button at least 2 seconds to turn off the UPS. UPS will be in standby mode under power normal or transfer to Bypass mode if the Bypass enable setting by pressing this button. ➤ Confirm selection key: Press this button to confirm selection in UPS setting mode.
Select Button	<ul style="list-style-type: none"> ➤ Switch LCD message: Press this button to change the LCD message for input voltage, input frequency, input current, battery voltage, battery current, battery capacity, ambient temperature, output voltage, output frequency, load current and load percent. ➤ Setting mode: Press and hold this button for 3 seconds to enter UPS setting mode when Standby and Bypass mode. ➤ Down key: Press this button to display next selection in UPS setting mode.
ON/Mute + Select Button	<ul style="list-style-type: none"> ➤ Switch to bypass mode: When the main power is normal, press ON/Mute and Select buttons simultaneously for 3 seconds. Then UPS will enter to bypass mode. This action will be ineffective when the input voltage is out of acceptable range. ➤ Exit setting mode or return to the upper menu: When working in setting mode, press ON/Mute and Select buttons simultaneously for 0.2 seconds to return to the upper menu. If it's already in top menu, press these two buttons at the same time to exit the setting mode.

3-2. LCD Panel



Display	Function
Backup time information	
	Indicates the estimated backup time. H: hours, M: minute, S: second.
Configuration and fault information	
	Indicates the configuration items, and the configuration items are listed in details in section 3-5.
	Indicates the warning and fault codes, and the codes are listed in details in section 3-7 and 3-8.
Mute operation	
	Indicates that the UPS alarm is disabled.
Input, Battery, Temperature, Output & Load information	
	Indicate the input voltage, input frequency, input current, battery voltage, battery current, battery capacity, ambient temperature, output voltage, output frequency, load current and load percent. k: kilo, W: watt, V: voltage, A: ampere, %: percent, °C: centigrade degree, Hz: frequency
Load information	
	Indicates the load level by 0-24%, 25-49%, 50-74% and 75-100%.
	Indicates overload.
Programmable outlets information	
	Indicates that programmable management outlets are working.
Mode operation information	
	Indicates the UPS connects to the mains.
	Indicates the battery is working.
	Indicates charging status
	Indicates the bypass circuit is working.
	Indicates the ECO mode is enabled.
	Indicates the AC to DC circuit is working.
	Indicates the PFC circuit is working.
	Indicates the inverter circuit is working.
	Indicates the UPS is working in converter mode.
	Indicates the output is working.
Battery information	
	Indicates the battery level by 0-24%, 25-49%, 50-74%, and 75-100%.
	Indicates low battery.

3-3. Audible Alarm

Battery Mode	Sounding every 5 seconds
Low Battery	Sounding every 2 seconds
Overload	Sounding every second
Fault	Continuously sounding
Bypass Mode	Sounding every 10 seconds

3-4. LCD display wordings index

Abbreviation	Display content	Meaning
ENA	ENR	Enable
DIS	di S	Disable
ESC	ESC	Escape
HLS	HLS	High loss
LLS	LLS	Low loss
AO	AO	Active open
AC	AC	Active close
EAT	EAt	Estimated autonomy time
RAT	rAt	Running autonomy time
SD	Sd	Shutdown
OK	OK	OK
ON	ON	ON
BL	bL	Battery Low
OL	OL	Over Load
OI	OI	Over input current
NC	nC	Battery No Connect
OC	OC	Over Charge
SF	SF	Site wiring fault
EP	EP	EPO
TP	tP	Temperature
CH	CH	Charger
BF	bF	Battery Fault
BV	bV	Bypass Out Range
FU	FU	Bypass frequency unstable
BR	bR	Battery Replace
EE	EE	EEPROM error

3-5. UPS Setting

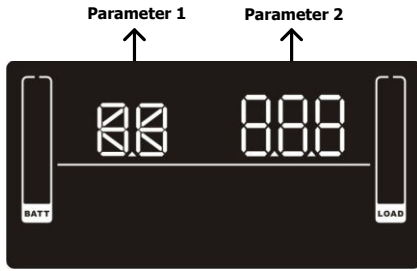

There are three parameters to set up the UPS. Parameter 1: It's for program alternatives. Refer to below table. Parameter 2 is the setting options or values for each program.

● 01: Output voltage setting

Interface	Setting
	<p>Parameter 2: Output voltage For 100/110/115/120/125/127Vac models, you may choose the following output voltage:</p> <p>100: presents output voltage is 100Vac 110: presents output voltage is 110Vac 115: presents output voltage is 115Vac 120: presents output voltage is 120Vac (Default) 125: presents output voltage is 125Vac 127: presents output voltage is 127Vac (127Vac is not applicable in USA region)</p>

● 02: Frequency Converter enable/disable

Interface	Setting
	<p>Parameter 2: Enable or disable converter mode. You may choose the following two options:</p> <p>CF ENA: converter mode enable CF DIS: converter mode disable (Default)</p>

● 03: Output frequency setting

Interface	Setting
	<p>Parameter 2: Output frequency setting. You may set the initial frequency on battery mode:</p> <p>BAT 50: presents output frequency is 50Hz BAT 60: presents output frequency is 60Hz</p> <p>If converter mode is enabled, you may choose the following output frequency:</p> <p>CF 50: presents output frequency is 50Hz CF 60: presents output frequency is 60Hz</p>

● 04: ECO enable/disable

Interface	Setting
	<p>Parameter 2: Enable or disable ECO function. You may choose the following two options:</p> <p>ENA: ECO mode enable DIS: ECO mode disable (Default)</p>

● **05: ECO voltage range setting**

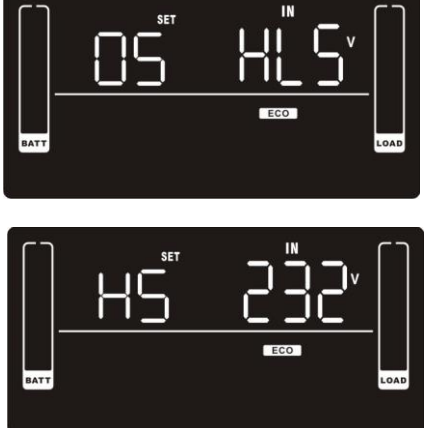
Interface	Setting
	<p>Parameter 2: Set the acceptable high voltage point and low voltage point for ECO mode by pressing Down key or Up key.</p> <p>HLS: High loss voltage in ECO mode in parameter 2. The setting range in parameter 3 is from +3V to +12V of the nominal voltage. (Default: +6V)</p> <p>LLS: Low loss voltage in ECO mode in parameter 2. The setting voltage in parameter 3 is from -3V to -12V of the nominal voltage. (Default: -6V)</p>

● **06: Bypass enable/disable when UPS is off**

Interface	Setting
	<p>Parameter 2: Enable or disable Bypass function. You may choose the following two options:</p> <p>ENA: Bypass enable</p> <p>DIS: Bypass disable (Default)</p>

● **07: Bypass voltage range setting**

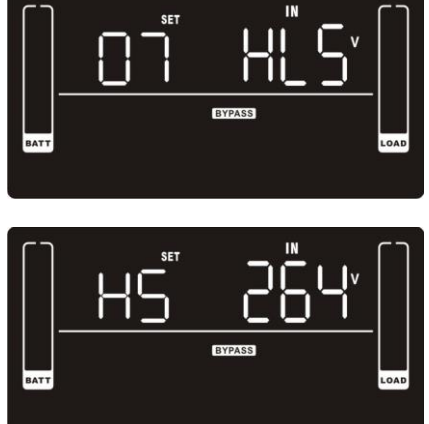
Interface	Setting
	<p>Parameter 2: Set the acceptable high voltage point and acceptable low voltage point for Bypass mode by pressing the Down key or Up key.</p> <p>HLS: Bypass high voltage point</p> <p>120-140: setting the high voltage point from 120Vac to 140Vac. (Default: 132Vac)</p> <p>LLS: Bypass low voltage point</p> <p>85-115: setting the low voltage point from 85Vac to 115Vac. (Default: 85Vac)</p>

● **08: Bypass frequency range setting**

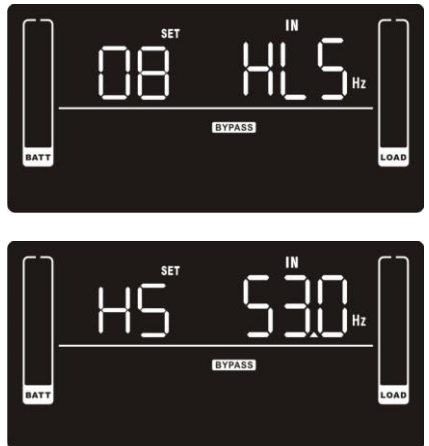
Interface	Setting
	<p>Parameter 2: Set the acceptable high frequency point and acceptable low frequency point for Bypass mode by pressing the Down key or Up key.</p> <p>HLS: Bypass high frequency point</p> <p>For 50Hz output frequency models:</p> <p>51-55Hz: setting the frequency high loss point from 51Hz to 55Hz. (Default: 53.0Hz)</p> <p>For 60Hz output frequency models:</p> <p>61-65Hz: setting the frequency high loss point from 61Hz to 65Hz. (Default: 63.0Hz)</p> <p>LLS: Bypass low Frequency point</p> <p>For 50Hz output frequency models:</p> <p>45-49Hz: setting the frequency low loss point from 45Hz to</p>

	49HZ. (Default: 47.0Hz) For 60Hz output frequency models: 55-59Hz: setting the frequency low loss point from 55Hz to 59Hz. (Default: 57.0Hz)
--	---

● **09: Programmable outlets enable/disable**

Interface	Setting
	Parameter 2: Enable or disable programmable outlets. ENA: Programmable outlets enable DIS: Programmable outlets disable (Default)

● **10: Programmable outlets setting**

Interface	Setting
	Parameter 2: Set up backup time limits for programmable outlets. 0-999: setting the backup time limits in minutes from 0-999 for programmable outlets which connect to non-critical devices on battery mode. (Default: 999)

● **11: Autonomy limitation setting**

Interface	Setting
	Parameter 2: Set up backup time on battery mode for general outlets. 0-999: setting the backup time in minutes from 0-999 for general outlets on battery mode. DIS: Disable the autonomy limitation and the backup time will depend on battery capacity. (Default) Note: When setting as "0", the backup time will be only 10 seconds.

● **12: Battery total AH setting**

Interface	Setting
	Parameter 2: Set up the battery total AH of the UPS. 7-999: setting the battery total capacity from 7-999 in AH. Please set the correct battery total capacity if external battery bank is connected.

● **13: Maximum charger current setting**

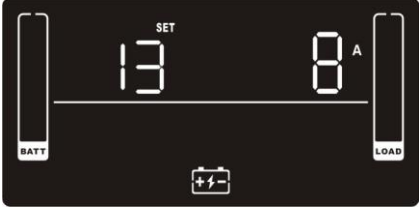
Interface	Setting										
	<p>Parameter 2: Set up the charger maximum current. 1/2/4/6/8: setting the charger maximum current 1/2/4/6/8 in Ampere. (Default: 2A) Note: Please set the appropriate charger current based on battery capacity used. The recommended charging current is 0.1C~0.3C of battery capacity as following table for reference.</p> <table border="1"> <thead> <tr> <th>Battery capacity(AH)</th> <th>Total charging current (A)</th> </tr> </thead> <tbody> <tr> <td>7~20</td> <td>2</td> </tr> <tr> <td>20~40</td> <td>4</td> </tr> <tr> <td>40~60</td> <td>6</td> </tr> <tr> <td>60~</td> <td>8</td> </tr> </tbody> </table>	Battery capacity(AH)	Total charging current (A)	7~20	2	20~40	4	40~60	6	60~	8
Battery capacity(AH)	Total charging current (A)										
7~20	2										
20~40	4										
40~60	6										
60~	8										

● **14: Charger boost voltage setting**

Interface	Setting
	<p>Parameter 2: Set up the charger boost voltage. 2.25-2.40: setting the charger boost voltage from 2.25 V/cell to 2.40V/cell. (Default: 2.36V/cell)</p>

● **15: Charger float voltage setting**

Interface	Setting
	<p>Parameter 2: Set up the charger float voltage. 2.20-2.33: setting the charger float voltage from 2.20 V/cell to 2.33V/cell. (Default: 2.28V/cell)</p>

● **16: EPO logic setting**

Interface	Setting
	<p>Parameter 2: Set up the EPO function control logic. AO: Active Open (Default). When AO is selected as EPO logic, it will activate EPO function with Pin 1 and Pin 2 in open status. AC: Active Close. When AC is selected as EPO logic, it will activate EPO function with Pin 1 and Pin 2 in close status.</p>

● **17: Site fault detection enable/disable**

Interface	Setting
	<p>Parameter 2: Enable or disable site fault detection. You may choose the following two options: ENA: Site fault detection enable (Default for 120Vac models) DIS: Site fault detection disable (Default for 230Vac models)</p>





● **18: Display setting for autonomy time**

Interface	Setting
	<p>Parameter 2: Set up the display setting for autonomy time</p> <p>EAT: If EAT is selected, it will display the remaining autonomy time. (Default)</p> <p>RAT: If RAT is selected, it will show accumulated autonomy time so far.</p>

● **00: Exit setting**

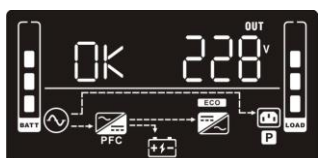
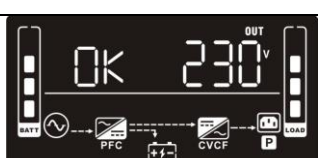
Interface	Setting
	<p>Exit the setting mode.</p>





















3-6. Operating Mode Description

Operating mode	Description	LCD display
Online mode	When the input voltage is within acceptable range, UPS will provide pure and stable AC power to output. The UPS will also charge the battery at online mode.	
ECO mode	Energy saving mode: When the input voltage is within voltage regulation range, UPS will bypass voltage to output for energy saving. The UPS will also charge the battery at ECO mode.	
Frequency Converter mode	When input frequency is within 40 Hz to 70 Hz, the UPS can be set at a constant output frequency, 50 Hz or 60 Hz. The UPS will still charge battery under this mode.	
Battery mode	When the input voltage is beyond the acceptable range or power failure, the UPS will backup power from battery and alarm is sounding every 5 seconds.	
Bypass mode	When input voltage is within acceptable range but UPS is overload, UPS will enter bypass mode or bypass mode can be set by front panel. Alarm is sounding every 10 seconds.	
Standby mode	UPS is powered off and no output supply power, but still can charge batteries.	
Fault mode	When a fault has occurred, the ERROR icon and the fault code will be displayed.	

3-7. Faults Reference Code

Fault event	Fault code	Icon	Fault event	Fault code	Icon
Bus start fail	01	x	Battery voltage too high	27	x
Bus over	02	x	Battery voltage too low	28	x
Bus under	03	x	Charger output short	2A	x
Inverter soft start fail	11	x	Over temperature	41	x
Inverter voltage high	12	x	Overload	43	
Inverter voltage Low	13	x	Charger failure	45	x
Inverter output short	14	x	Over input current	49	x













3-8. Warning indicator

Warning	Icon (flashing)	Code	Alarm
Low Battery	 	bL	Sounding every 2 seconds
Overload	 	OL	Sounding every second
Over input current		OI	Sounding 2 beep every 10 seconds
Battery is not connected	 	NC	Sounding every 2 seconds
Over Charge	 	OC	Sounding every 2 seconds
Site wiring fault	 	SF	Sounding every 2 seconds
EPO enable		EP	Sounding every 2 seconds
Over temperature		EP	Sounding every 2 seconds
Charger failure		CH	Sounding every 2 seconds
Battery fault		bF	Sounding every 2 seconds (At this time, UPS is off to remind users something wrong with battery)
Out of bypass voltage range	 	bV	Sounding every 2 seconds
Bypass frequency unstable		FU	Sounding every 2 seconds
Battery replacement		bT	Sounding every 2 seconds
EEPROM error		EE	Sounding every 2 seconds

NOTE: "Site Wiring Fault" function can be enabled/disabled via software. Please check software manual for the details.

4. Troubleshooting

If the UPS system does not operate correctly, please solve the problem by using the table below.

Symptom	Possible cause	Remedy
No indication and alarm even though the mains is normal.	The AC input power is not connected well.	Check if input power cord firmly connected to the mains.
	The AC input is connected to the UPS output.	Plug AC input power cord to AC input correctly.
The icon  and the warning code  flash on LCD display and alarm is sounding every 2 seconds.	EPO function is activated.	Set the circuit in closed position to disable EPO function.
The icons of  and  , and the warning code  flash on LCD display. Alarm is sounding every 2 seconds.	Line and neutral conductors of UPS input are reversed.	Rotate mains power socket by 180° and then connect to UPS system.
The icons of  and  and the warning code  flash on LCD display. Alarm is sounding every 2 seconds.	The external or internal battery is incorrectly connected.	Check if all batteries are connected well.
Fault code is shown as 27 on LCD display and alarm is continuously sounding.	Battery voltage is too high or the charger is fault.	Contact your dealer.
Fault code is shown as 28 on LCD display and alarm is continuously sounding.	Battery voltage is too low or the charger is fault.	Contact your dealer.
The icons  and  and the warning code  flash on LCD display. Alarm is sounding every second.	UPS is overload	Remove excess loads from UPS output.
	UPS is overloaded. Devices connected to the UPS are fed directly by the electrical network via the Bypass.	Remove excess loads from UPS output.
	After repetitive overloads, the UPS is locked in the Bypass mode. Connected devices are fed directly by the mains.	Remove excess loads from UPS output first. Then shut down the UPS and restart it.
Fault code is shown as 49 on LCD display and alarm is continuously sounding.	UPS is over input current.	Remove excess loads from UPS output.
Fault code is shown as 43 and the icon  is lighting on LCD display. Alarm is continuously sounding.	The UPS shut down automatically because of overload at the UPS output.	Remove excess loads from UPS output and restart it.

Symptom	Possible cause	Remedy
Fault code is shown as 14 on LCD display and alarm is continuously sounding.	The UPS shut down automatically because short circuit occurs on the UPS output.	Check output wiring and if connected devices are in short circuit status.
Fault code is shown as 01, 02, 03, 11, 12, 13 and 41 on LCD display and alarm is continuously sounding.	A UPS internal fault has occurred. There are two possible results: 1. The load is still supplied, but directly from AC power via bypass. 2. The load is no longer supplied by power.	Contact your dealer
Battery backup time is shorter than nominal value.	Batteries are not fully charged	Charge the batteries for at least 5 hours and then check capacity. If the problem still persists, consult your dealer.
	Batteries defect	Contact your dealer to replace the battery.
Fault code is shown as 2A on LCD display and alarm is continuously sounding.	The short circuit occurs on the charger output.	Check if battery wiring of connected external pack is in short circuit status.
Fault code is shown as 45 on LCD display. At the same time, alarm is continuously sounding.	The charger does not have output and battery voltage is less than 10V/PC.	Contact your dealer.

5. Storage and Maintenance

Operation

The UPS system contains no user-serviceable parts. If the battery service life (3~5 years at 25°C ambient temperature) has been exceeded, the batteries must be replaced. In this case, please contact your dealer.



Be sure to deliver the spent battery to a recycling facility or ship it to your dealer in the replacement battery packing material.

Storage

Before storing, charge the UPS 5 hours. Store the UPS covered and upright in a cool, dry location. During storage, recharge the battery in accordance with the following table:

Storage Temperature	Recharge Frequency	Charging Duration
-25°C - 40°C	Every 3 months	1-2 hours
40°C - 45°C	Every 2 months	1-2 hours

6. Specifications

MODEL	DTK-UPS1000R+	DTK-UPS1500R+	DTK-UPS2000R+	DTK-UPS3000R+
CAPACITY*	1000VA/1000W	1500VA/1500W	2000VA/2000W	3000VA / 3000W
INPUT				
Voltage Range	Low Line Transfer	80VAC/70VAC/60VAC/55VAC \pm 5 % (based on load percentage 100% - 80 % / 80 % - 70 % / 70 - 60 % / 60 % - 0)		
	Low Line Comeback	87VAC/77VAC/67VAC/62VAC \pm 5 %		
	High Line Transfer	150 VAC \pm 5 %		
	High Line Comeback	145 VAC \pm 5 %		
Frequency Range	40Hz ~ 70 Hz			
Phase	Single phase with ground			
Power Factor	\geq 0.99 @ full load			
THDI	\leq 5% @ 160-265Vac or 80~140Vac THDU < 1.6% @ input and full linear load condition			
OUTPUT				
Output voltage	100/110/115/120/125/127 VAC**			
AC Voltage Regulation	\pm 1% (Batt. Mode)			
Frequency Range (Synchronized Range)	47 ~ 53 Hz or 57 ~ 63 Hz			
Frequency Range	50 Hz \pm 0.1 Hz or 60Hz \pm 0.1 Hz (Batt. Mode)			
Current Crest Ratio	3:1			
Harmonic Distortion	\leq 2 % THD (Linear Load) ; 4 % THD (Non-linear Load)			
Transfer Time	AC Mode to Batt. Mode	Zero		
	Inverter to Bypass	< 4 ms		
Waveform (Batt. Mode)	Pure Sinewave			
EFFICIENCY				
AC Mode	\geq 89% @ full charged battery		\geq 91% @ full charged battery	
ECO Mode	\geq 96% @ full charged battery			
Battery Mode	\geq 88%		\geq 90%	
BATTERY				
Battery Type	12V/9AH	12V/9AH	12V/9AH	12V/9AH
Numbers	2	3	4	6
Recharge Time	3 hours recover to 95% capacity for internal battery@ 2A charging current			
Charging Current	Default: 2A, Max: 8A adjustable			
Charging Voltage	27.4 VDC \pm 1%	41.0 VDC \pm 1%	54.7 VDC \pm 1%	82.1 VDC \pm 1%
PHYSICAL				
Dimension, D X W X H (mm)	410 x 438 x 88		510 x 438 x 88	630 x 438 x 88
Net Weight (kgs)	With battery	11.6	15.5	19.5
	Without battery	6.6	8.1	9.4
ENVIRONMENT				
Operation Humidity	20-95 % RH @ 0- 40°C (non-condensing)			
Noise Level	Less than 50dba @ 1 Meter (With fan speed control)			
MANAGEMENT				
Smart RS-232 or USB	Supports Windows® 2000/2003/XP/Vista/2008/7/8/10, Linux, Unix and MAC			
Optional SNMP	Power management from SNMP manager and web browser			

* Derate capacity to 90% of capacity when the output voltage is adjusted to 100VAC.

**For 120VAC system, the output power ratings are different based on different input voltage. Please check output power rating table for the details. (127 is not applicable to USA region)

*** Product specifications are subject to change without further notice.

Output Power Rating Table (only for 100/110/115/120/125 VAC system)

Model name	Input rating	Output rating
DTK-UPS1000R+	100-125Vac, 50/60Hz, 12A, 1Ø	100/110/115/120/125Vac, 50/60Hz, 1Ø 1000VA/1000W,8A (@125Vac input) ; 1000VA/1000W,8.3A (@120Vac input) ; 1000VA/1000W,8.7A (@115Vac input) ; 1000VA/1000W,9.1A (@110Vac input) ; 900VA/900W,9A (@100Vac input)
DTK-UPS1500R+	100-125Vac, 50/60Hz, 12A, 1Ø	100/110/115/120/125Vac, 50/60Hz, 1Ø 1500VA/1430W,12A (@125Vac input) ; 1500VA/1300W,12.5A (@120Vac input) ; 1500VA/1270W,13A (@115Vac input) ; 1500VA/1200W,13.6A (@110Vac input) ; 1350VA/1040W,13.5A (@100Vac input)
DTK-UPS2000R+	100-125Vac, 50/60Hz, 16A, 1Ø	100/110/115/120/125Vac, 50/60Hz, 1Ø 2000VA/1930W,16A (@125Vac input) ; 2000VA/1850W,16.7A (@120Vac input) ; 2000VA/1740W,17.4A (@115Vac input) ; 2000VA/1640W,18.2A (@110Vac input) ; 1800VA/1500W,18A (@100Vac input)
DTK-UPS3000R+	100-125Vac, 50/60Hz, 24A, 1Ø	100/110/115/120/125Vac, 50/60Hz, 1Ø 3000VA/2850W,24A (@125Vac input) ; 3000VA/2740W,25A (@120Vac input) ; 3000VA/2650W,26.1A (@115Vac input) ; 3000VA/2500W,27.3A (@110Vac input) ; 2700VA/2300W,27A (@100Vac input)

Runtime Chart In Minutes (internal battery)

Model	DTK-UPS1000R+	DTK-UPS1500R+	DTK-UPS2000R+	DTK-UPS3000R+
Battery	(9Ah x 2)	(9Ah x 3)	(9Ah x 4)	(9Ah x 6)
Load percentage				
100.00%	2.43	2.57	2.43	2.64
90.00%	3.19	3.36	3.19	3.36
80.00%	4.14	4.34	4.06	4.34
70.00%	5.31	5.42	5.31	5.53
60.00%	6.93	6.93	7.06	7.33
50.00%	9.44	9.46	9.56	9.79
40.00%	12.92	12.89	13.20	13.51
30.00%	18.52	18.43	19.12	19.90
20.00%	29.90	29.44	31.06	32.61
10.00%	63.67	61.16	68.38	72.53

Battery Pack Specification

Model	DTK-UXB1000R+	DTK-UXB1500R+	DTK-UXB2000R+	DTK-UXB3000R+
Used with UPS Models	DTK-UPS1000R+	DTK-UPS1500R+	DTK-UPS2000R+	DTK-UPS3000R+
Battery Type	12V 9Ah	12V 9Ah	12V 9Ah	12V 9Ah
Battery Numbers	4	6	8	12
Dimensions (DxWxH) mm	380 x 438 x 88		480 x 438 x 88	600 x 438 x 88
Net Weight(kgs)	17.1	21.5	29	41.2

NOTE: Battery pack should be used with corresponded UPS.